

NAKKA

The Choice Of Life

DC Frequency Conversion Fan

Bionic Natural Wind



NAKKA

NAKKA Environmental Appliance Technology Co., Ltd
Add: No.3 Zhongjian road, zhongyong industrial area, Leliu Town, Foshan
City, Guangdong Province

Tel: 86-0757-25556223 E: nakka@nakka.cn

www.nakka.net

www.nakka.net

NAKKA

COMPANY PROFILE

NAKKA Smart DC Technology and products is a manufacturing enterprise that focuses on production and development of high technology smart appliances primarily with household floor fans, commercial, industrial and ventilation fans.

With a quality oriented attitude, innovative and pragmatic spirit of research and development within the Research and Development team our company has successfully developed and patented a DC (Direct Current) motor fan to be an industry leader. What makes this DC motor unique is it is more energy efficient, low noise, smooth operation which allows NAKKA products to last longer than other electric fans.

THE CHOICE OF LIFE



CE RoHS ERP RED
Energy-related Products

www.nakka.net



Fully Sealed Smart DC Motor

Moisture proof | Dust-proof | Energy conservation | Long-lasting

Energy Consumption Of Industrial Fan Per Month

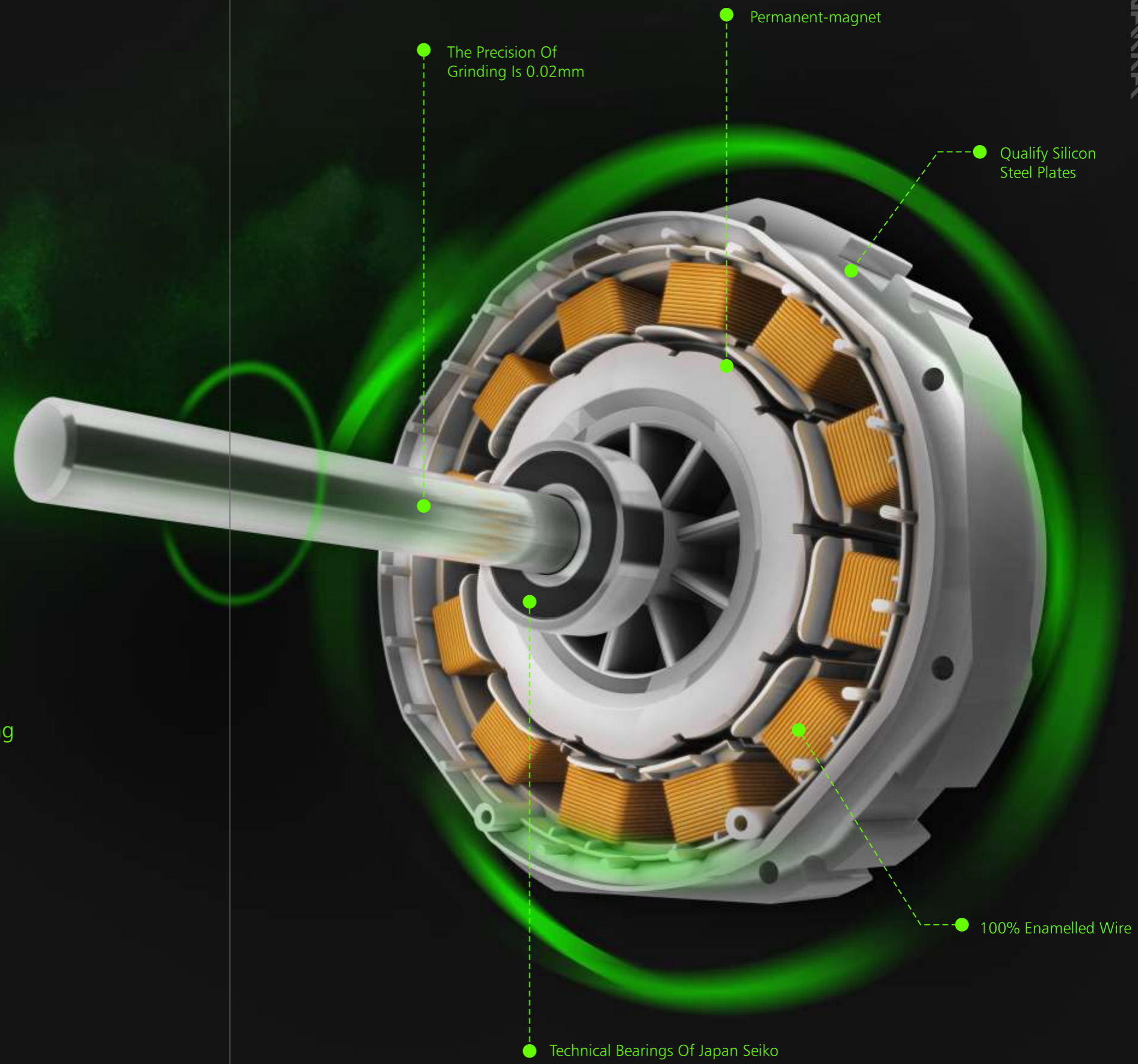
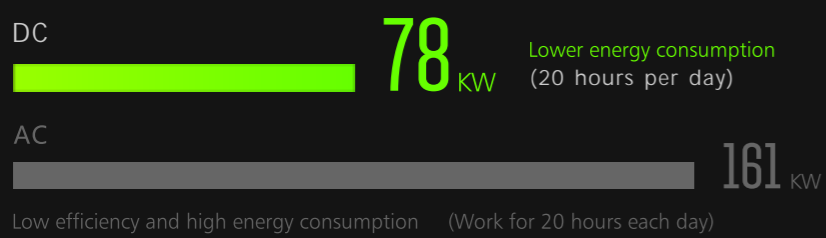

DC motor

The sine wave noise reduction technology makes the motor work more quiet.

Sine Wave Schematic Diagram

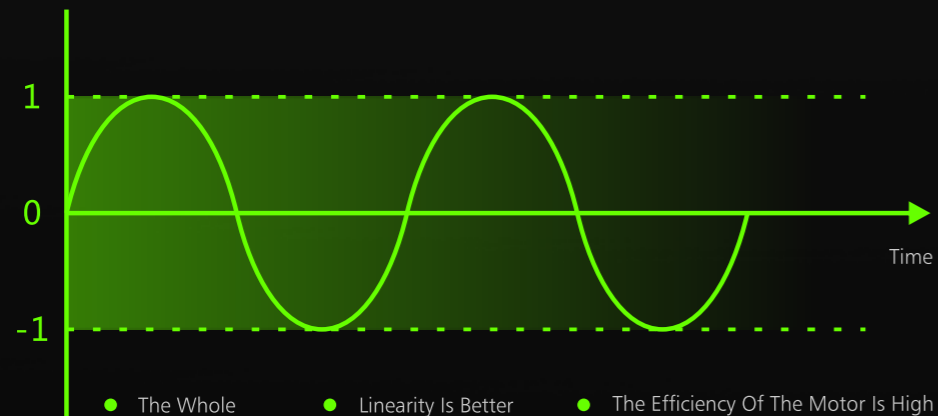

- The Whole Course Is Quiet
- Linearity Is Better Than Square Wave
- The Efficiency Of The Motor Is High And The Waveform Is More Consistent With The Working Principle Of The Motor

Square Wave Schematic Diagram



- Big Shock When Starting
- Large Electromagnetic Sound
- Low Efficiency



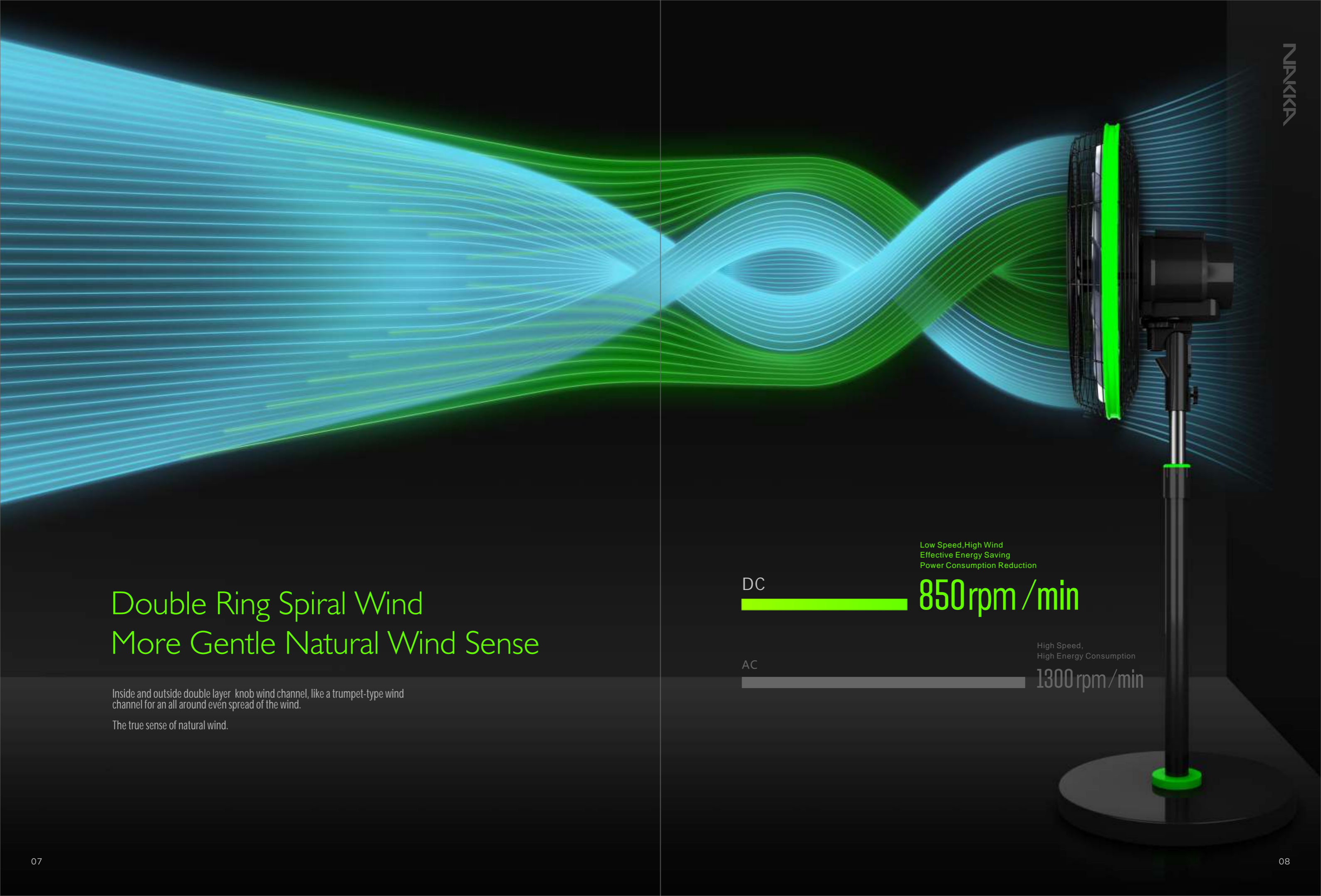

Double Ring Spiral Wind More Gentle Natural Wind Sense

Inside and outside double layer knob wind channel, like a trumpet-type wind channel for an all around even spread of the wind.

The true sense of natural wind.

Low Speed, High Wind
Effective Energy Saving
Power Consumption Reduction

DC **850 rpm / min**

AC **1300 rpm / min**

High Speed,
High Energy Consumption

Disordered Frequency Conversion Bionic Natural Wind

The three-dimensional smooth and disorderly wind shows the wind speed, and the air volume is fast and slow. Strong, weak, random, not repeated, but it is the closest to the natural world.

Air volume frequency 600 times per minute

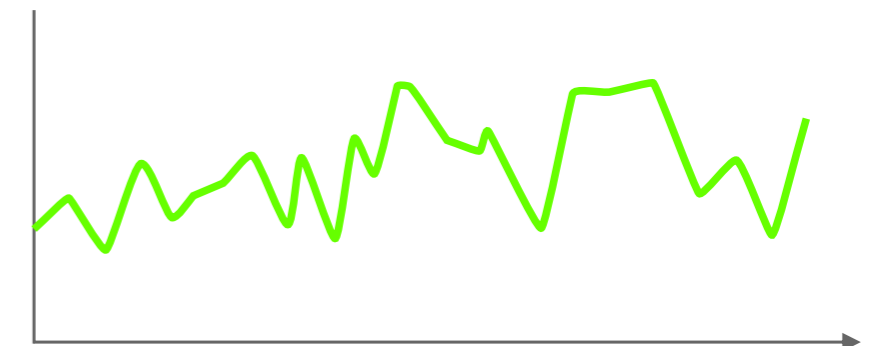

Frequency conversion bionic natural wind equation algorithm



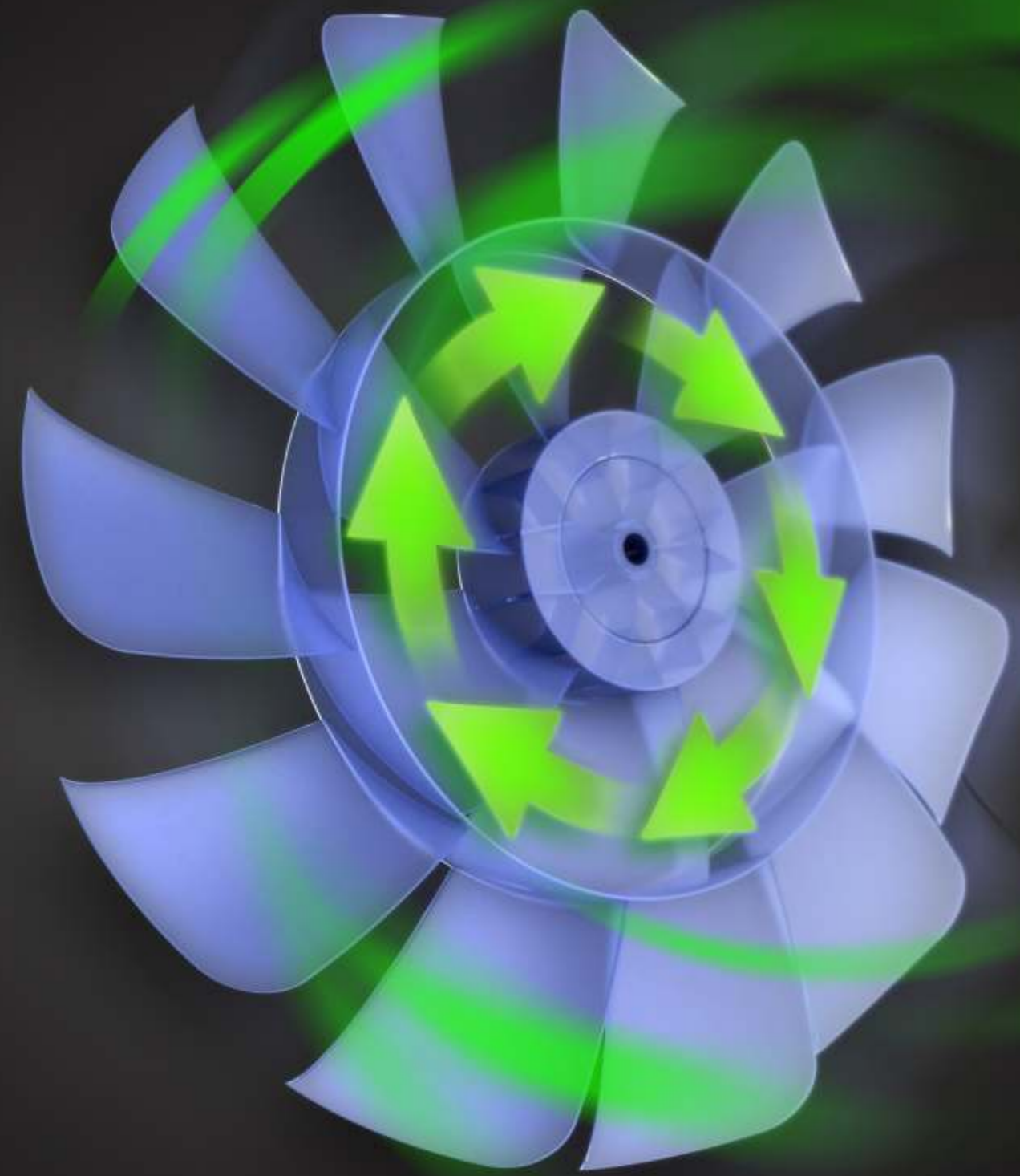

18 Blades Design Mute Technique

The wind cutting is more uniform, the wind is soft and the air supply is wider.

18 Blade Air Volume

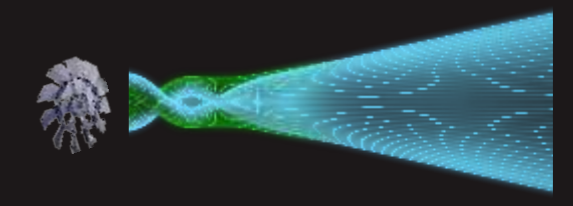

5 Blade Air Volume

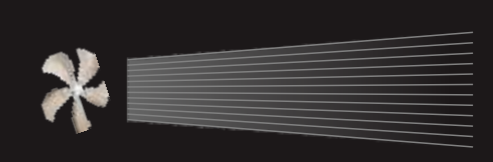

Wide-angle Air Supply

Wide-angled shaped air supply angle is up to 120 degrees enables every person in the room, where ever located enjoy the cool breeze and feel from the EC fan.

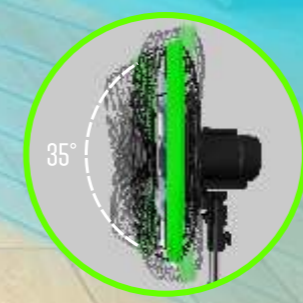

Up And Down

35°



Shake Your Head

90°



Extended Height

27cm

Remote Control

Wireless remote control uses 433Hz radio remote control technology. The Smart DC fan can effectively be controlled over 20 meters in an open area.

Equipped with a magnetic device for easy storage on the face of the DC fan.

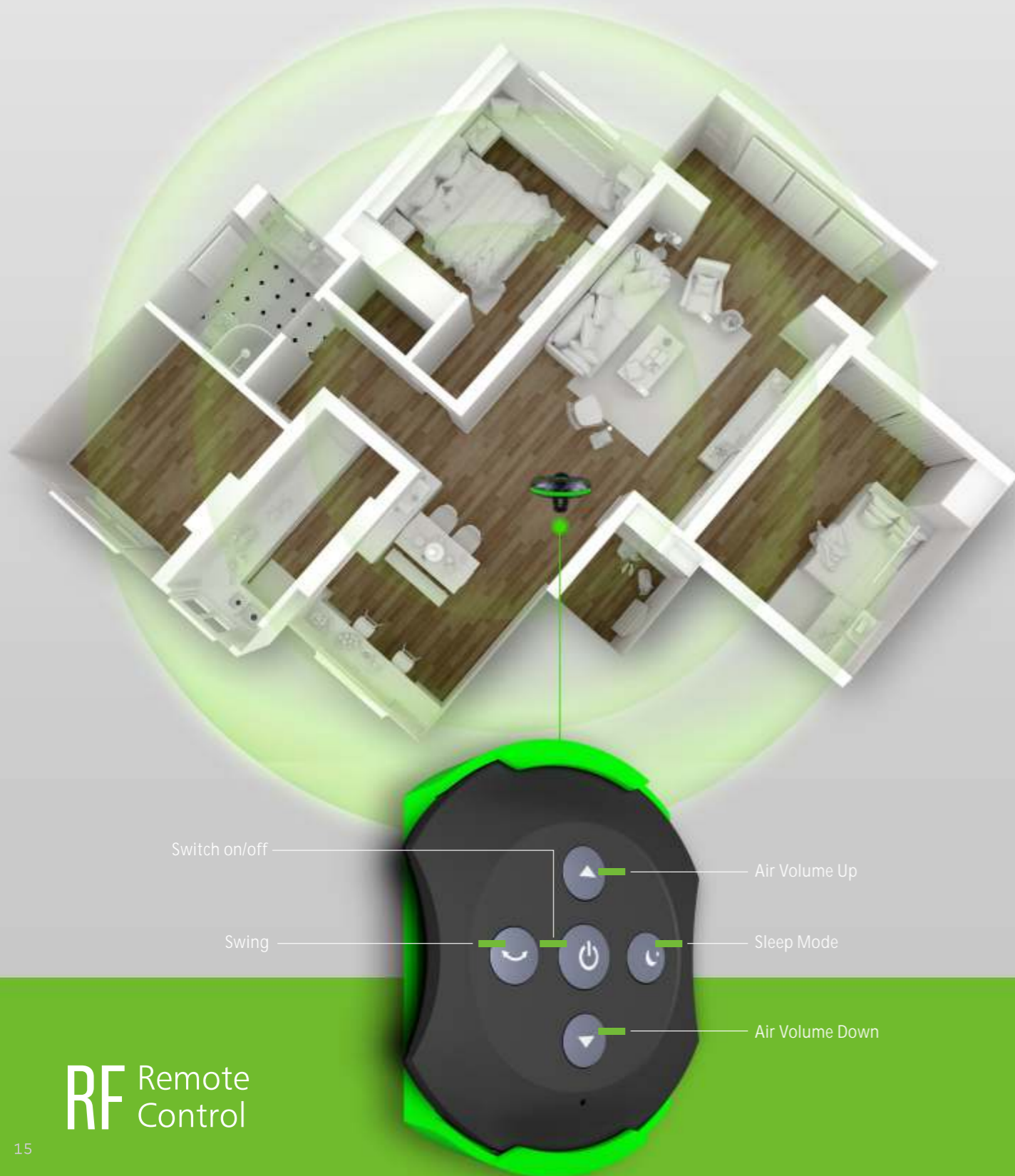

RF Remote Control

Magnet

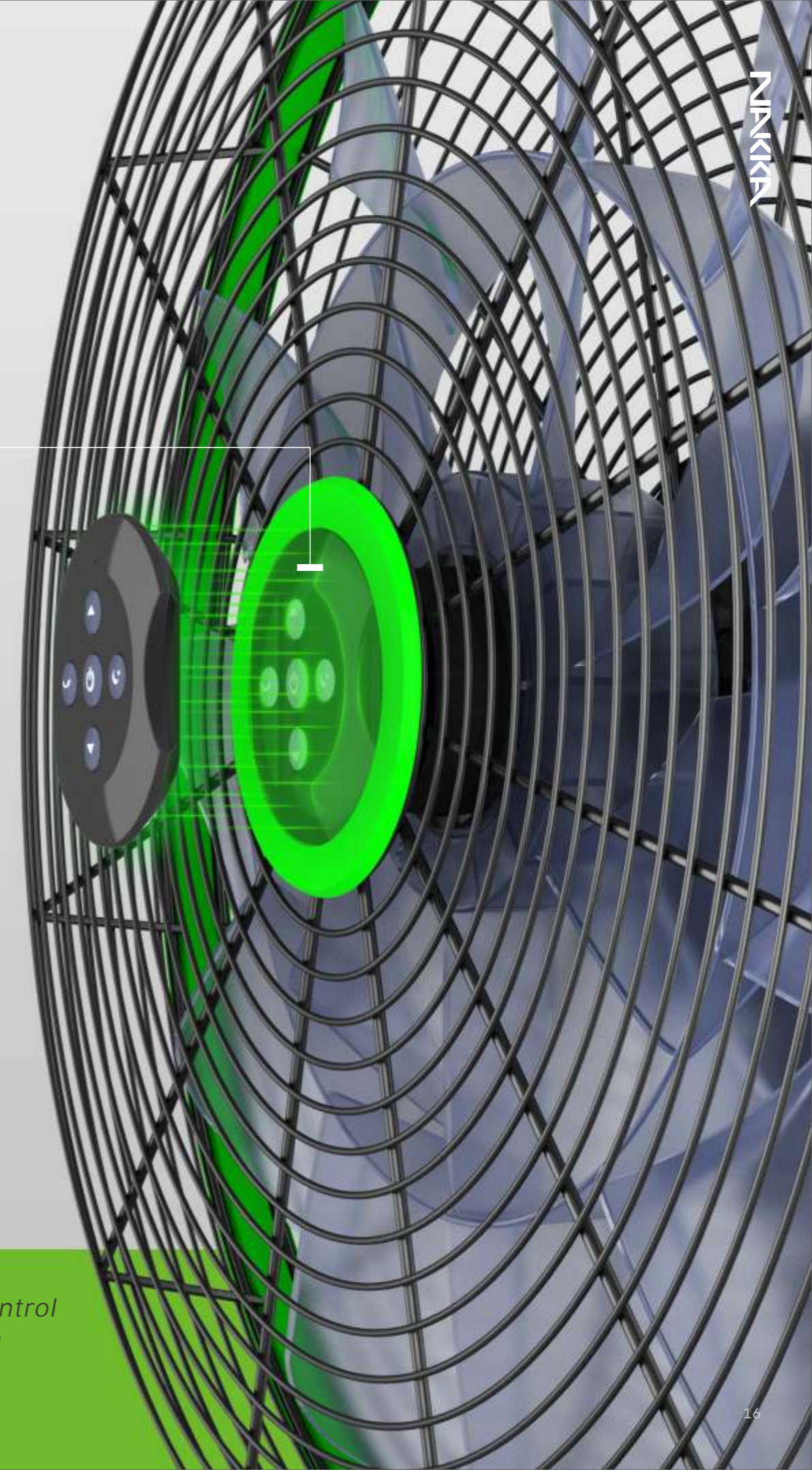

Unique Remote Control holder design

Multi-protection System

Overcurrent protection | Overvoltage protection | Motor blockage protect

Patented Fan Grill Net Cover with a circular structure, double-track sided frame with safety lock for additional protection for smaller hands and fingers



Main line diameter



Vice line diameter

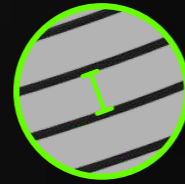

Line spacing

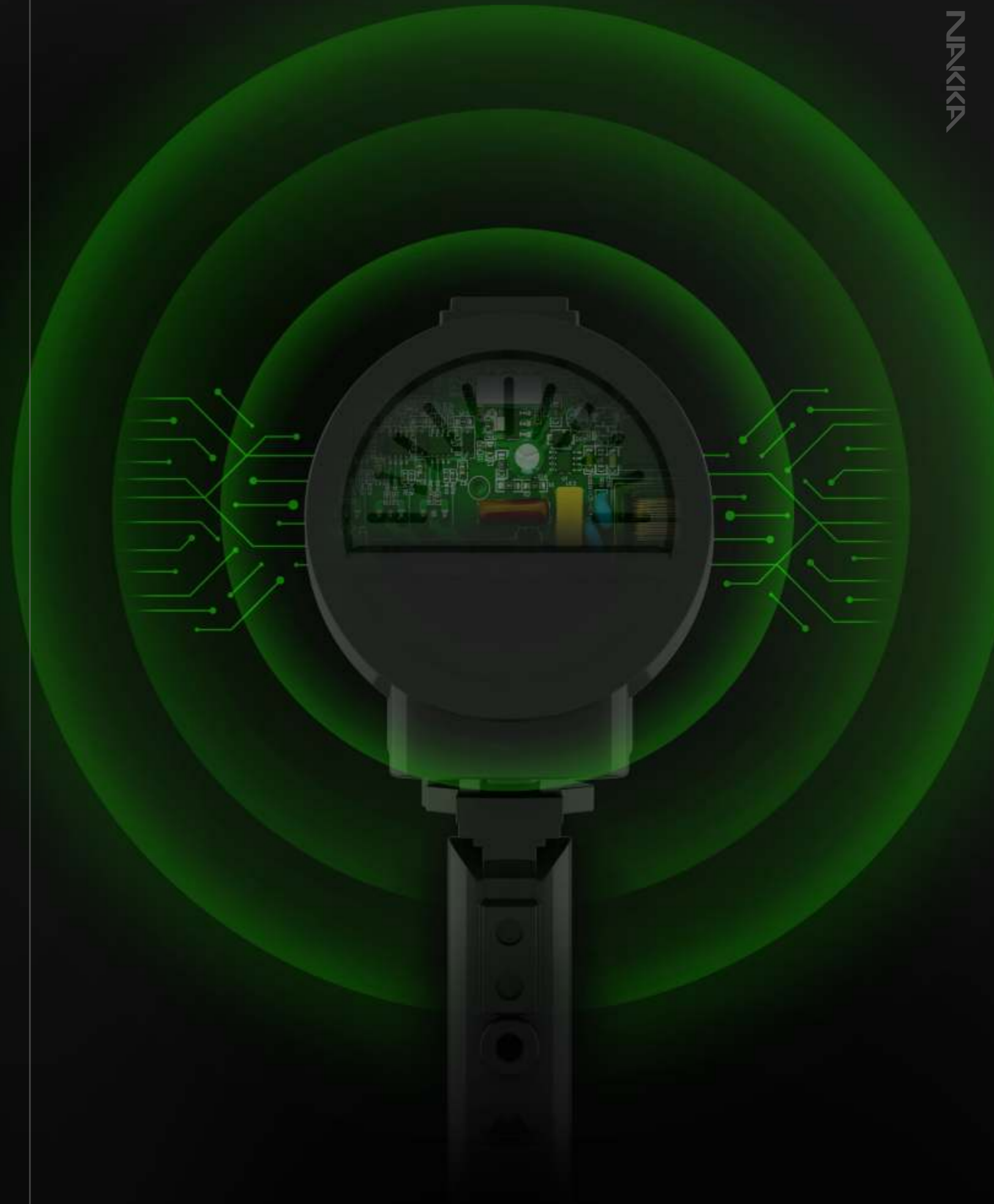
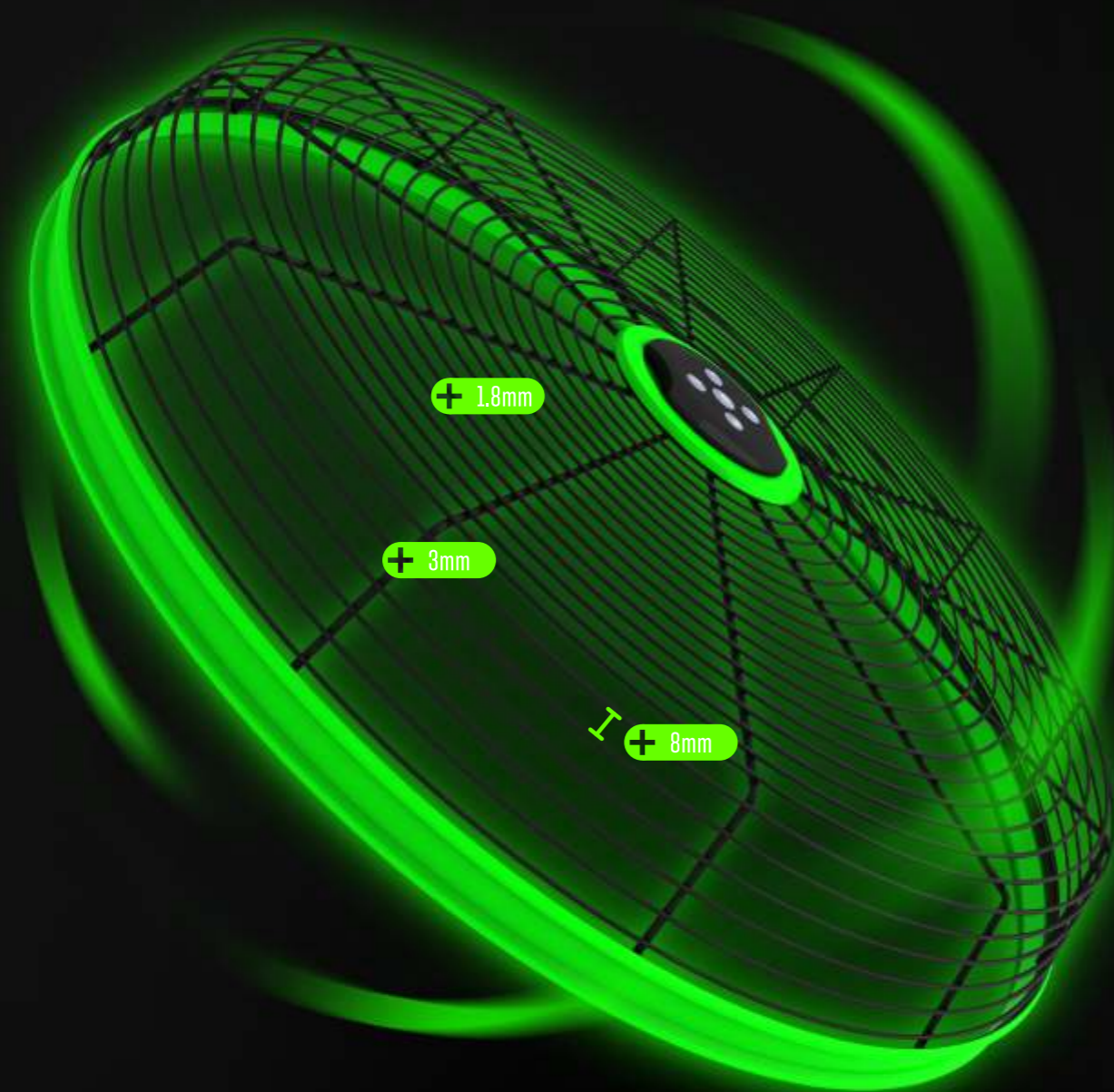

A Quiet Time That Is Not Disturbed

Undisturbed And Peaceful Sleep
Operating With Low Noise, Soft And Quiet.

The combination of gentle and natural wind and a comfortable environment
makes you feel as if you are in nature.



Intelligent Timer Setting

An automatic shutdown time up to 9 hours, depending on your current room environment to ensure a more comfortable experience.



Intelligent Control

3 Different Type Of Wind Function
6 Levels Of Wind Speed

RF REMOTE CONTROL

WiFi



6 Gear Speed Adjustable



Natural wind







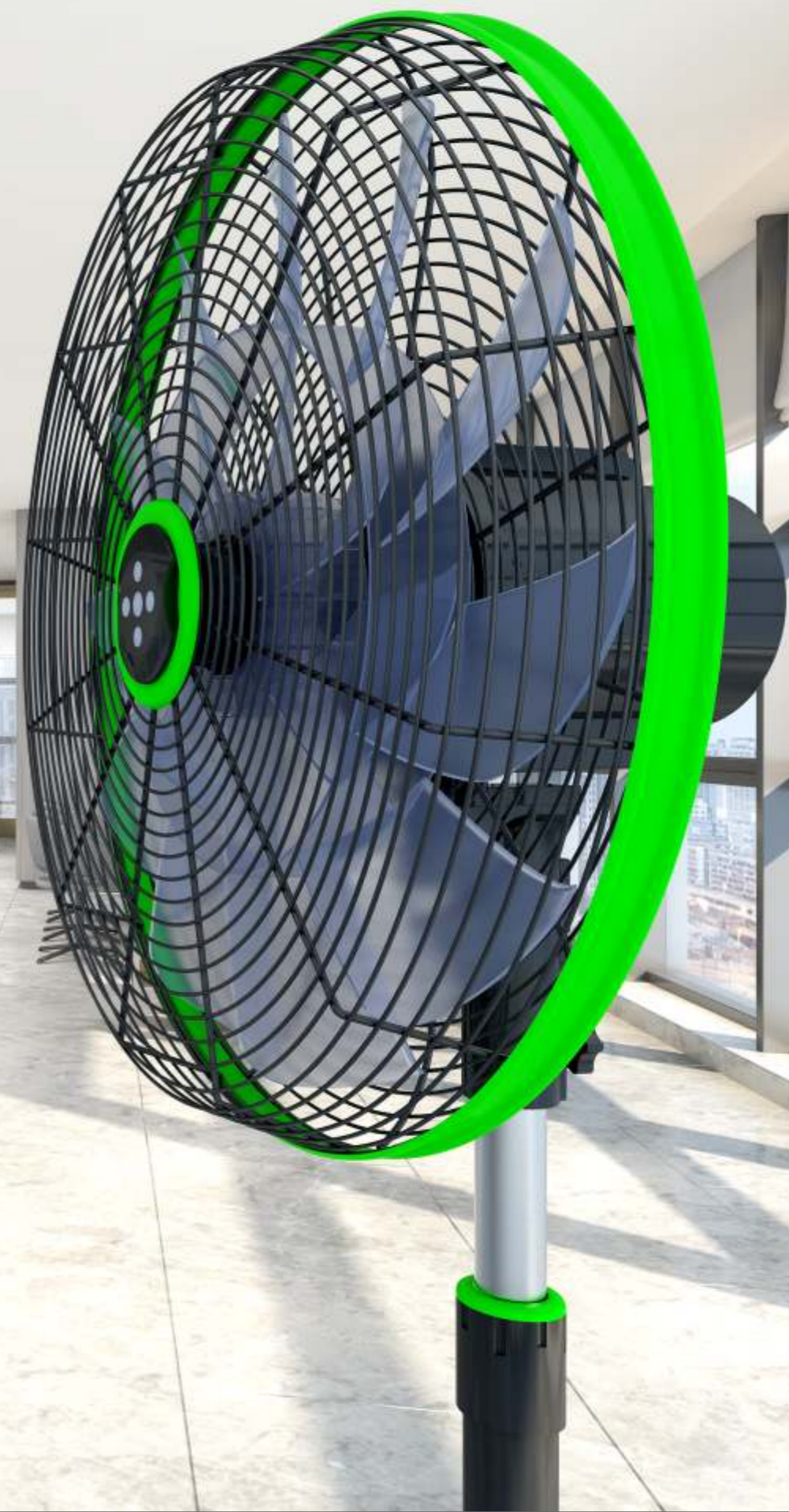

Sleep wind



Smart DC
Commercial Fan
Series



Model: FS45-DC17ARL

-  DC Motor
-  Strong wind
-  Mute
-  Remote Control
-  Energy conservation
-  Safety Refinements

Size	18 inch (450mm)
Rated power	18W-90W
Rated voltage(V)	200-240V/100-120V
Maximum wind volume	167 m ³ /min
Fan sound power level	56db
Adjustable in height	108-135cm
Left&right air supply angle	90°
Up&down air supply angle	35°
Controler frequency	433Hz

Gross weight	11.6kg
Net weight	9.7kg
Packing size	52*35*53cm 73.5*19.5*52.5cm







20 GP capacity	256	419
40 GP capacity	520	838
40 HC capacity	604	959



RF REMOTE CONTROL

DC Frequency Conversion Fan

Model: FS45D-DC17ARL

-  DC Motor
-  Strong wind
-  Mute
-  Remote Control
-  Energy conservation
-  Safety Refinements

Size	18 inch (450mm)*2
Rated power	18W-180W
Rated voltage(V)	200-240V/100-120V
Maximum wind volume	167*2 m ³ /min
Fan sound power level	56*2 db
Adjustable in height	155-170cm
Left&right air supply angle	90°
Up&down air supply angle	35°
Controler frequency	433Hz







Gross weight	20.8kg
Net weight	18.1kg
Packing size	83*24.5*54cm

20 GP capacity	252
40 GP capacity	508
40 HC capacity	568



RF REMOTE CONTROL

Model: FM45-DC17ARL

-  DC Motor
-  Strong wind
-  Mute
-  Remote Control
-  Energy conservation
-  Safety Refinements

Size	18 inch (450mm)
Rated power	18W-160W
Rated voltage(V)	200-240
Maximum wind volume	167 m ³ /min
Fan sound power level	56db
Water tank volume	2 liter
Continuous spray	5-8 hours
Effective area	20 m
Spray droplet	0.05-0.20mg
Controler frequency	433Hz
Gross weight	14.5kg
Net weight	12kg
Packing size	52*50*52cm
20 GP capacity	176
40 GP capacity	384
40 HC capacity	480

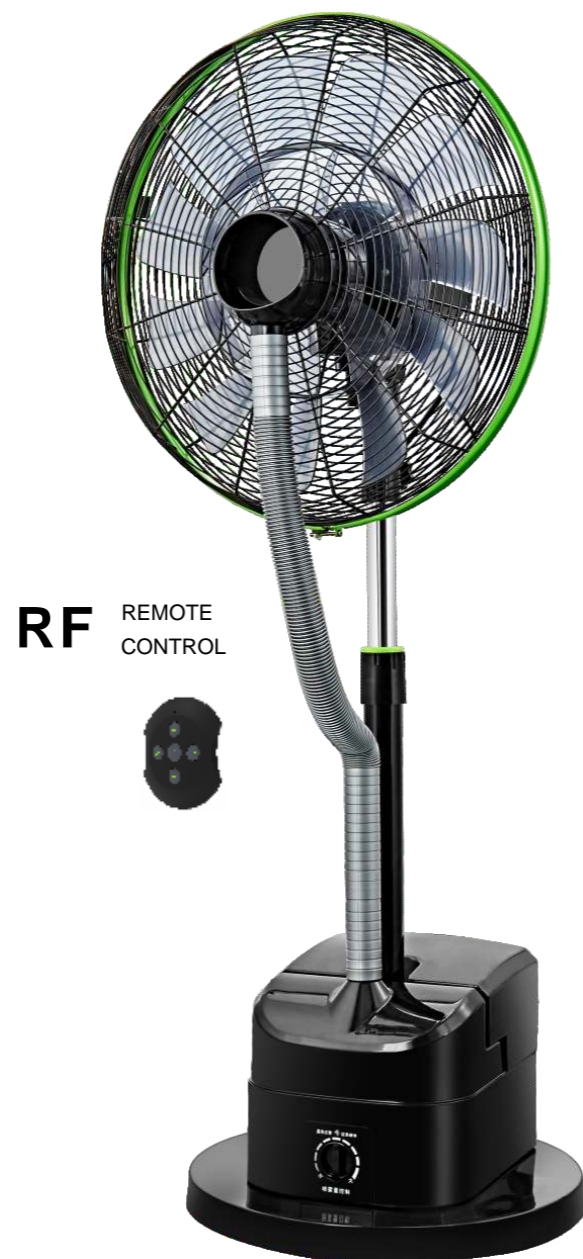

RF REMOTE CONTROL



Model: FS45-DC17BL / FS50-DC17BL

-  DC Motor
-  Strong wind
-  Mute
-  Control Panel
-  Energy conservation
-  Safety Refinements

	FS45-DC17BL	FS50-DC17BL
Size	18 inch (450mm)	20 inch (500mm)
Rated power	4W-90W	4W-90W
Rated voltage(V)	200-240V/100-120V	
Maximum wind volume	167 m ³ /min	167 m ³ /min
Fan sound power level	63db	63db
Adjustable in height	108-135cm	
Left&right air supply angle	90°	
Up&down air supply angle	35°	
Gross weight	10.8kg	12kg
Net weight	8.9kg	10.3kg
Packing size	73*19*52.5cm	79*20*58cm
20 GP capacity	367	287
40 GP capacity	818	660
40 HC capacity	884	715







RF REMOTE CONTROL



(Optional)

Model: FTS45-DC17ARL

-  Strong wind
-  Mute
-  Remote Control
-  DC Motor
-  Energy conservation
-  Safety Refinements







RF REMOTE CONTROL



Size	18 inch (450mm)
Rated power	18W-90W
Fan sound power level	56db
Adjustable in height	58cm
Left&right air supply angle	90°
Up&down air supply angle	35°
Controler frequency	433Hz
Gross weight	11.6kg
Net weight	9.7kg
Packing size	73.5*19.5*52.5cm

Rated voltage(V)	200-240V/100-120V
Maximum wind volume	167 m ³ /min
20 GP capacity	419
40 GP capacity	838
40 HC capacity	959

Model: FTS45-DC17BL

-  Strong wind
-  Mute
-  Control Panel
-  DC Motor
-  Energy conservation
-  Safety Refinements

RF REMOTE CONTROL







(Optional)



Size	18 inch (450mm)
Rated power	4W-90W
Fan sound power level	63db
Adjustable in height	58cm
Left&right air supply angle	90°
Up&down air supply angle	35°
Gross weight	11.6kg
Net weight	9.7kg
Packing size	73*19*52.5cm

Rated voltage(V)	200-240V/100-120V
Maximum wind volume	167 m ³ /min
20 GP capacity	367
40 GP capacity	818
40 HC capacity	884

Model: FW45-DC17ARL







-  Strong wind
-  Mute
-  Remote Control
-  DC Motor
-  Energy conservation
-  Safety Refinements

RF REMOTE CONTROL



Size	18 inch (450mm)	Rated voltage(V)	200-240V/100-120V
Rated power	18W-90W	Maximum wind volume	167 m ³ /min
Fan sound power level	56db	20 GP capacity	352
Left&right air supply angle	90°	40 GP capacity	792
Up&down air supply angle	35°	40 HC capacity	896
Controler frequency	433Hz		
Gross weight	10.8kg		
Net weight	8.9kg		
Packing size	52.5*27.5*53.5cm		

Model: FW45-DC17BRL

-  Strong wind
-  Mute
-  Remote Control
-  DC Motor
-  Energy conservation
-  Safety Refinements

RF REMOTE CONTROL



Size	18 inch (450mm)	Rated voltage(V)	200-240V/100-120V
Rated power	4W-90W	Maximum wind volume	167 m ³ /min
Fan sound power level	63db	20 GP capacity	352
Left&right air supply angle	90°	40 GP capacity	792
Up&down air supply angle	35°	40 HC capacity	896
Controler frequency	433Hz		
Gross weight	10.8kg		
Net weight	8.9kg		
Packing size	52.5*27.5*53.5cm		

Smart DC
Industrial Fan
Series



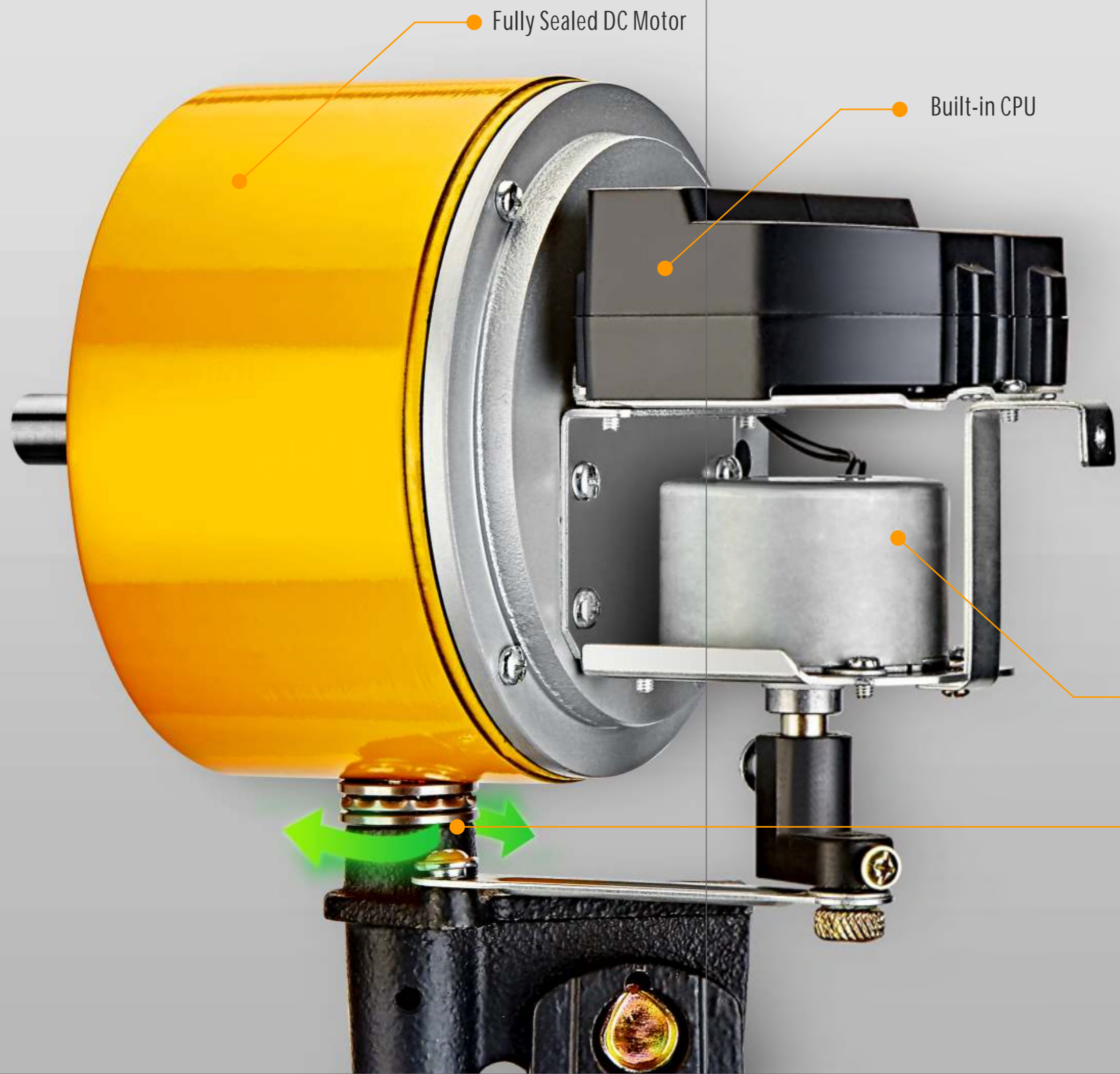

Fully Sealed DC Motor

Built-in CPU

Science and Electronic Technology

Using high-torque synchronous motor electronic control Technology, the swing of the head angle can be freely controlled.

The plate bearing is included in the design to support the main patented DC motor, which greatly reduces the friction generated by the fan pendulum so that the synchronous motor has less stress and prolongs the service life of NAKKA smart DC commercial and industrial fans.

Model: FS75-DC17ARL

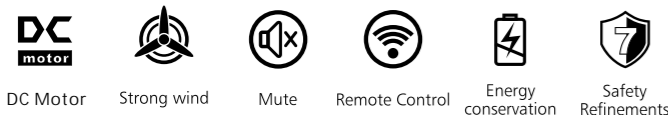

Performance

Pole Adjustable pole
 Base 8kg plastic pedestal (can past 12° ramp testing)
 Grill 30 inch 24 lines strong grill (pass the finger testing)
 Blade 30 inch 3 blades Aluminum design (lowest noise , max air volume)
 Power Cable 3*0.75mm 100% copper power line(The length of the power cord is 1.8m)

Size	30 inch (750mm)
Rated power	25W-130W
Rated voltage(V)	200-240V/100-120V
Maximum wind volume	314.6m³/min
Fan sound power level	72db
Left&right air supply angle	75°
Up&down air supply angle	40°
Adjustable in height	151-168cm

Gross weight	24kg
Net weight	21.2kg
Packing size	82.5*8*82.5cm 25*19*32cm 52.5*8.5*52.5cm 7*7*98cm
One fan one container	85*20.5*85cm

20 GP capacity	300	172
40 GP capacity	650	324
40 HC capacity	740	408



Model: FS65-DC17BL

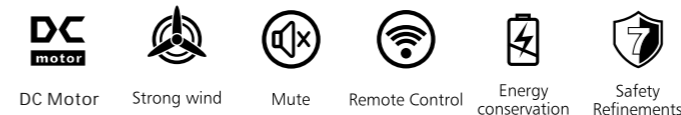

Performance

Pole Adjustable pole
 Base 7kg plastic pedestal (can past 12° ramp testing)
 Grill 26 inch 16 lines strong grill (pass the finger testing)
 Blade 26 inch 3 blades Aluminum design (lowest noise , max air volume)
 Power Cable 3*0.75mm 100% copper power line(The length of the power cord is 1.8m)







Size	26 inch (650mm)
Rated power	20W-130W
Rated voltage(V)	200-240V/100-120V
Maximum wind volume	251 m³/min
Fan sound power level	63db
Left&right air supply angle	75°
Up&down air supply angle	40°
Adjustable in height	145-162cm

Gross weight	20.7kg
Net weight	18.7kg
Packing size	72*8*72cm 25*19*32cm 52.5*8.5*52.5cm 7*7*98cm
One fan one container	97*21*73cm

20 GP capacity	350	198
40 GP capacity	730	402
40 HC capacity	830	473



Model: FW75-DC17ARL

-  DC Motor
-  Strong wind
-  Mute
-  Remote Control
-  Energy conservation
-  Safety Refinements

Performance

Grill 30 inch 24 lines strong grill (pass the finger testing)
Blade 30 inch 3 blades Aluminum design (lowest noise, max air volume)
Power Cable 3*0.75mm 100% copper power line(The length of the power cord is 1.8m)

Size	30 inch (750mm)
Rated power	25W-130W
Rated voltage(V)	200-240V/100-120V
Maximum wind volume	251 m ³ /min
Fan sound power level	58db
Left&right air supply angle	75°
Up&down air supply angle	40°

Gross weight	14.14kg
Net weight	11.9kg
Packing size	82.5*8*82.5cm 25.5*19*32cm
One fan one box	85*20.5*85cm







20 GP capacity	435	180
40 GP capacity	900	376
40 HC capacity	1000	471



RF REMOTE CONTROL



Model: FW65-DC17ARL

-  DC Motor
-  Strong wind
-  Mute
-  Remote Control
-  Energy conservation
-  Safety Refinements

Performance

Grill 26 inch 12 lines strong grill
Blade 26 inch 3 blades Aluminum design (lowest noise, max air volume)
Power Cable 3*0.75mm 100% copper power line(The length of the power cord is 1.8m)

Size	26 inch (650mm)
Rated power	20W-130W
Rated voltage(V)	200-240V/100-120V
Maximum wind volume	251 m ³ /min
Fan sound power level	63db
Left&right air supply angle	75°
Up&down air supply angle	40°

Gross weight	10.72kg
Net weight	9.65kg
Packing size	72*8*72cm 25.5*19*32cm
One fan one box	97*21*73cm

20 GP capacity	535	198
40 GP capacity	1110	402
40 HC capacity	1250	473

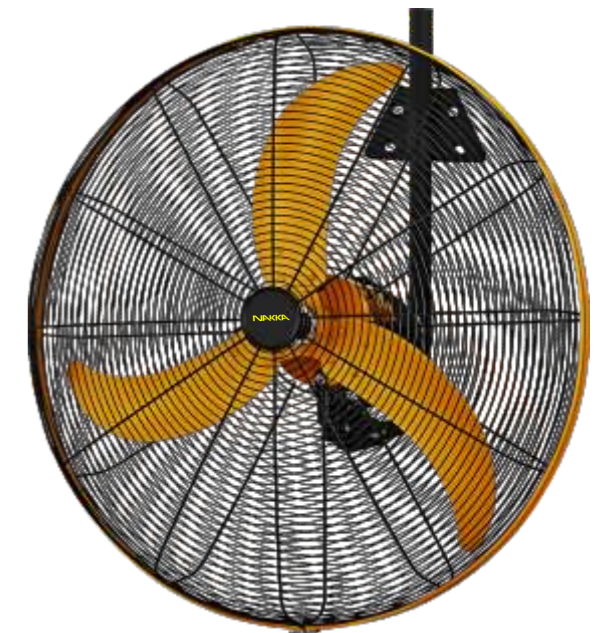

RF REMOTE CONTROL



Model: FD60-DC20ARL-P

- DC Motor
- Strong wind
- Mute
- Remote Control
- Energy conservation
- Safety Refinements

IP54 WATERPROOF Fan

Size	24 INCH
Rated power	150W
Rated voltage(V)	200-240V/100-120V
Oscillation Degree	360°
Control panel	touched control panel
Fan mode	6 wind speeds, 9h timer, strong wind mode

Gross weight	16.65kg
Net weight	14.9kg
Packing size	94.5*24*96cm

Optional Size	24" 30" 36" 42" 48"
---------------	---------------------



RF REMOTE CONTROL



Model: FW50-DC20ARL-P

- DC Motor
- Strong wind
- Mute
- Remote Control
- Energy conservation
- Safety Refinements

IP54 WATERPROOF Fan

Size	20 INCH
Rated power	135W
Rated voltage(V)	200-240V/100-120V
Oscillation Degree	360°
Control panel	touched control panel
Fan mode	6 wind speeds, 9h timer, strong wind mode

Gross weight	7.8kg
Net weight	6.6kg
Packing size	62*20*63cm

20 GP capacity	369
40 GP capacity	768
40 HC capacity	929



RF REMOTE CONTROL



Smart DC
Household
Fan Series



Model: FW40-DC22ARL

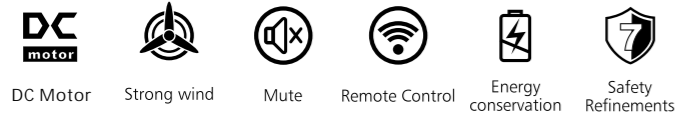

Size	16 INCH
Rated power	28W
Rated voltage(V)	200-240V/100-120V
Control panel	touched control panel
Fan mode	9 wind speeds, 9h timer, strong wind mode, sleep mode, natural wind mode
Gross weight	4.13 kg
Net weight	3.13 kg
Packing size	49*17*58cm
Rotate speed	
20 GP capacity	626
40 GP capacity	1290
40 HC capacity	1476

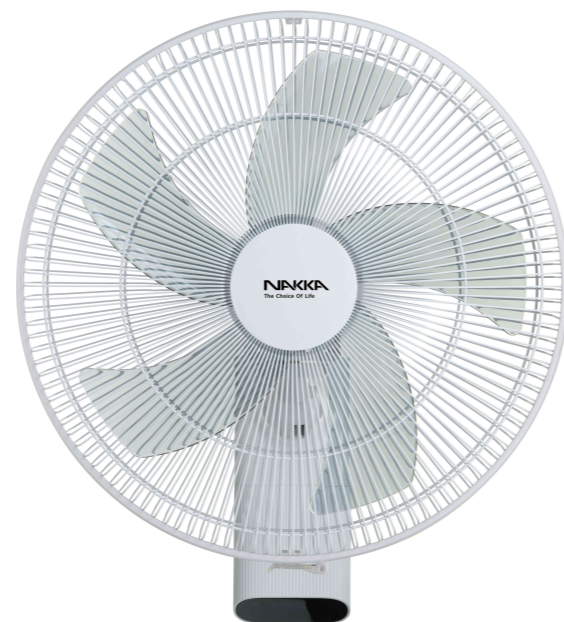

INFRARED

REMOTE CONTROL

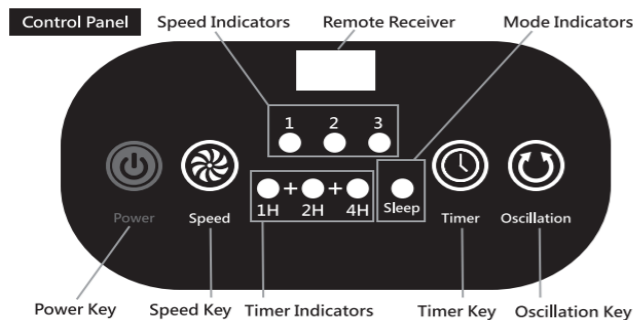

DC Frequency Conversion Fan

NAKKA

Model: FS40-DC22ARL

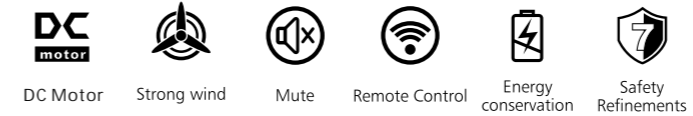

Size	16 INCH
Rated power	30W
Rated voltage(V)	200-240V/100-120V
Control panel	touched control panel
Fan mode	9 wind speeds, 9h timer, strong wind mode, natural wind mode
Maximum wind volume	68m³/s
Gross weight	6.62kg
Net weight	5.73kg
Packing size	59*16*46.5cm
Rotate speed	1-550rpm 4-900rpm 2-700rpm 5-1050rpm 3-750rpm 6-1200rpm
20 GP capacity	600
40 GP capacity	1420
40 HC capacity	1500



INFRARED

REMOTE CONTROL

